

LEGO

7+

8779



KNIGHTS' KINGDOM



3 GAME CARDS INCLUDED
3 CARTES DE JEU INCLUSES



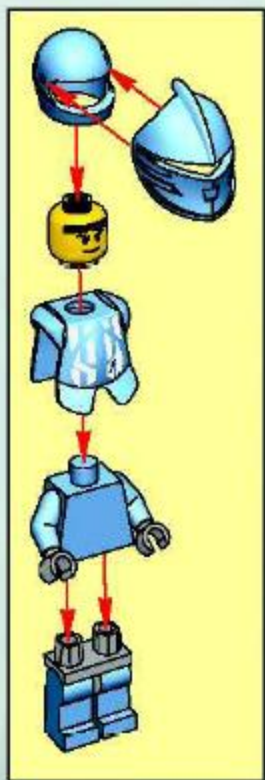

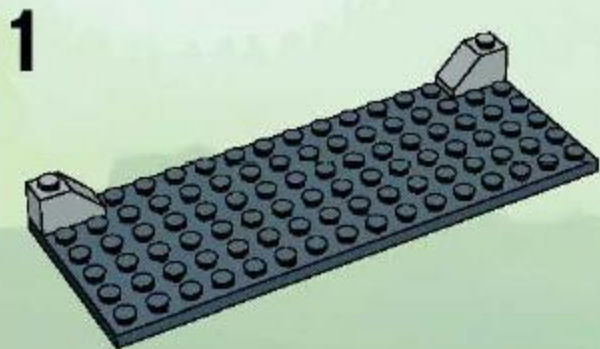

2

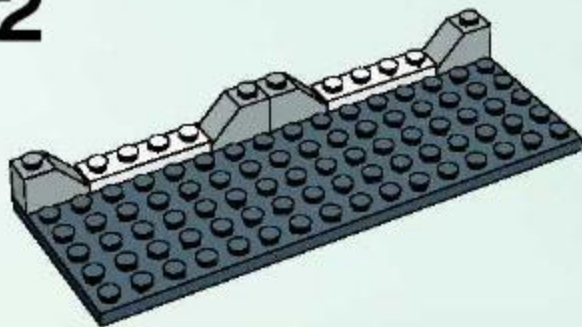

3

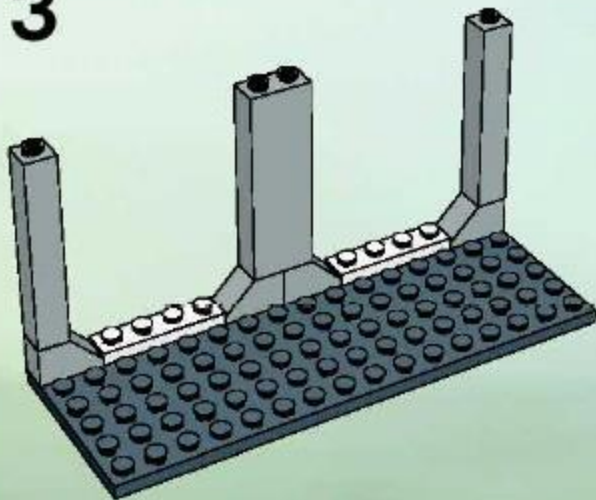

4

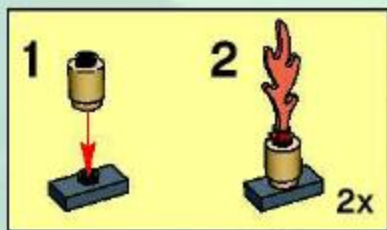
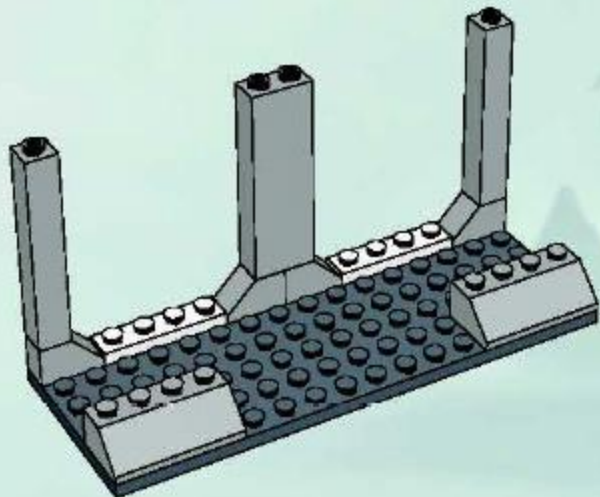

5

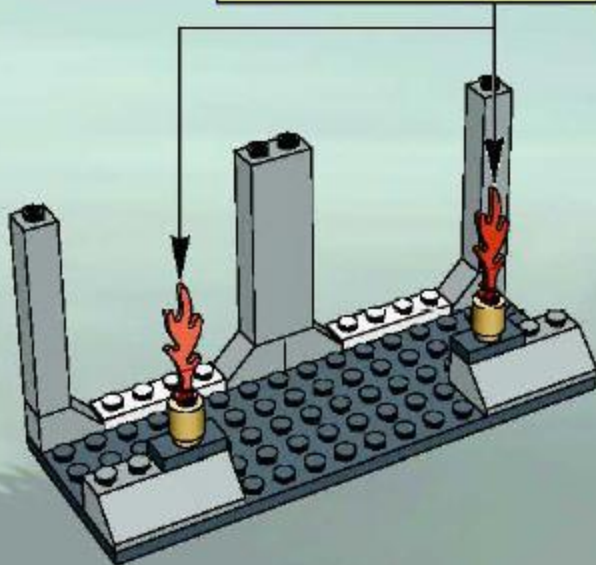

6

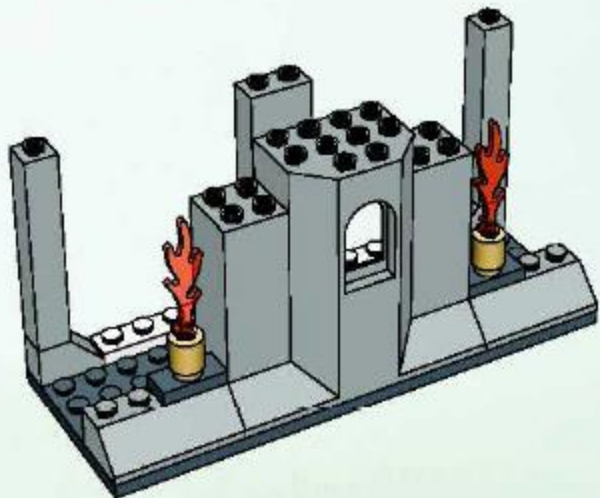

7

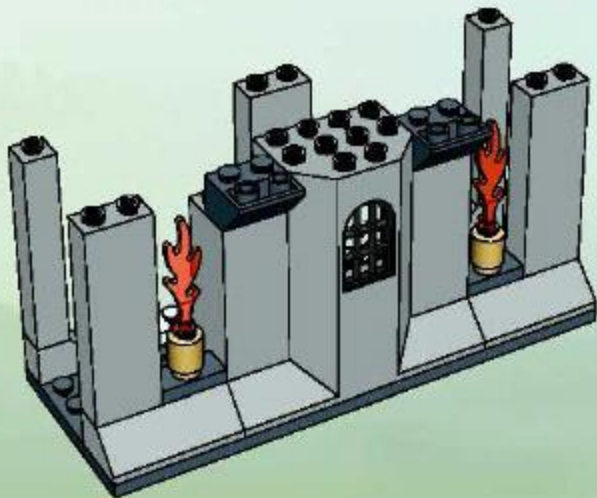

8

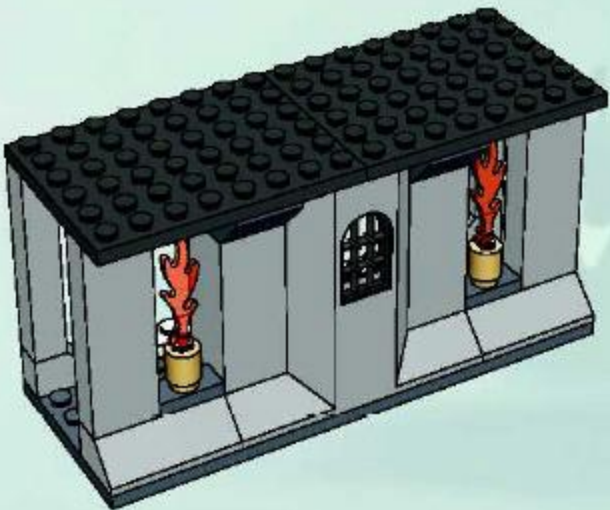

9

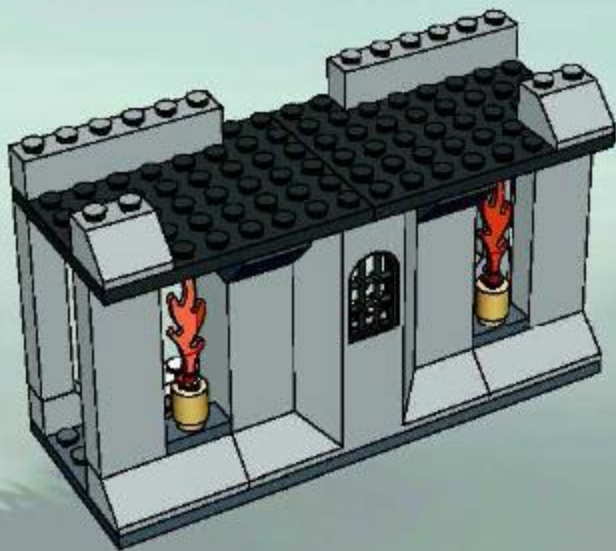

10

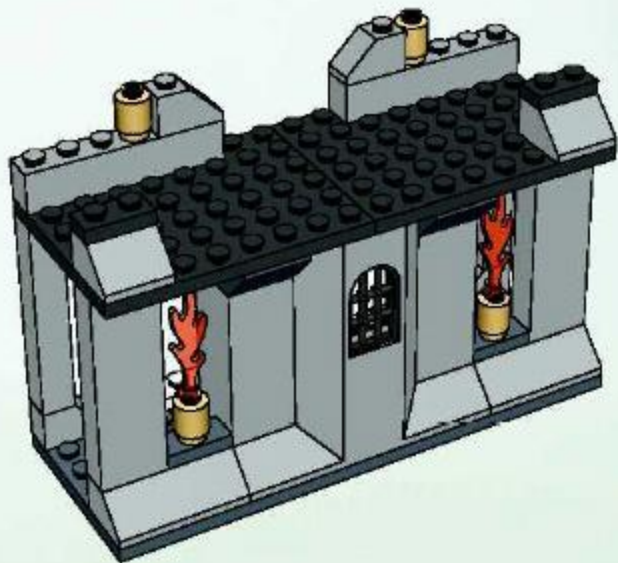

11

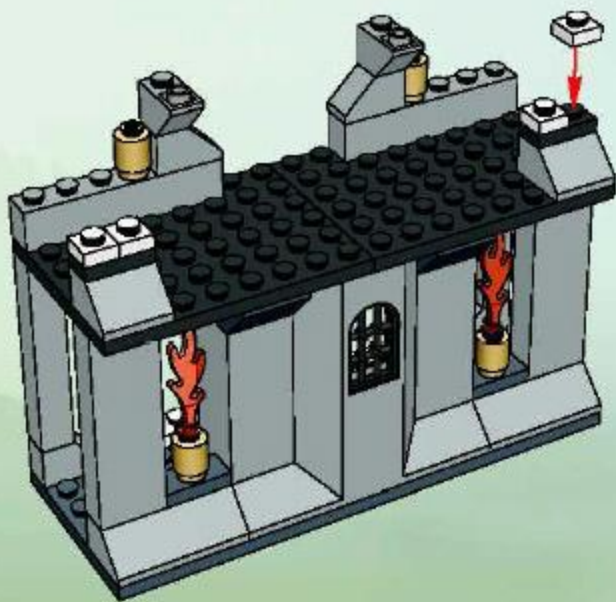

12

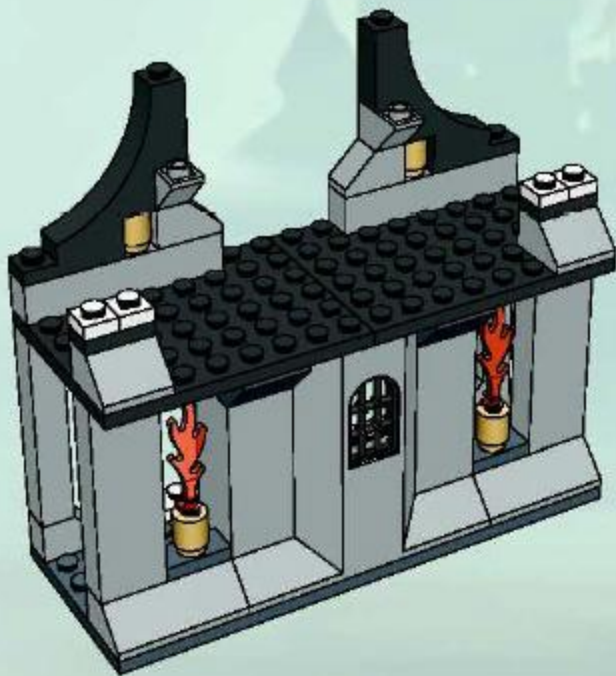

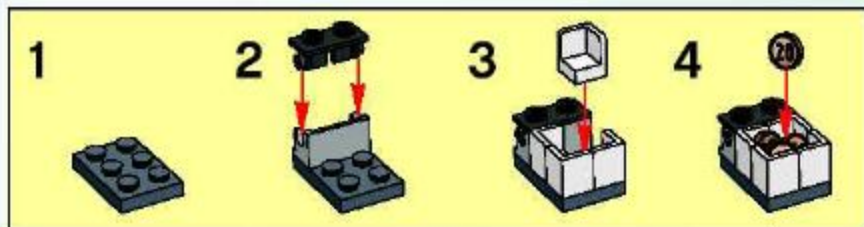

13

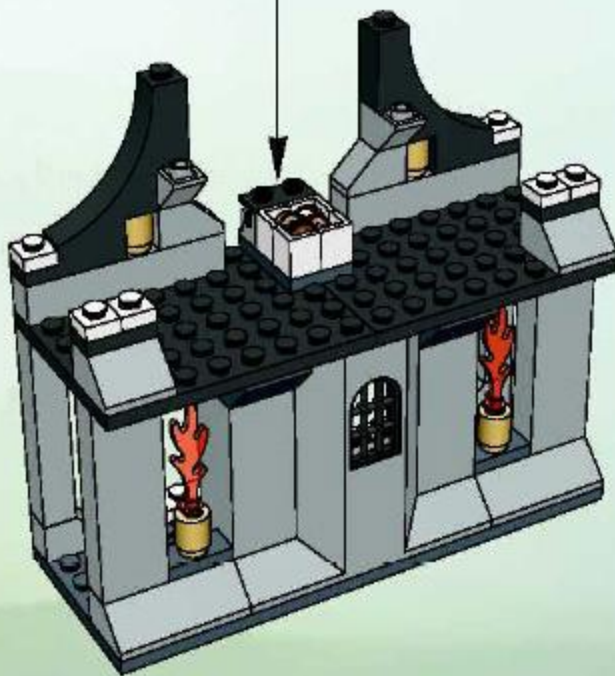

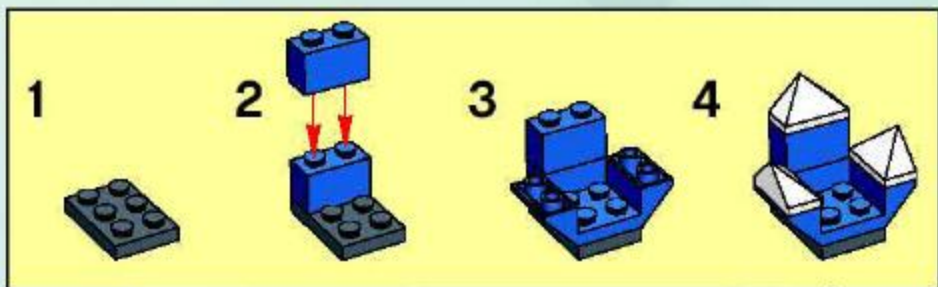

14

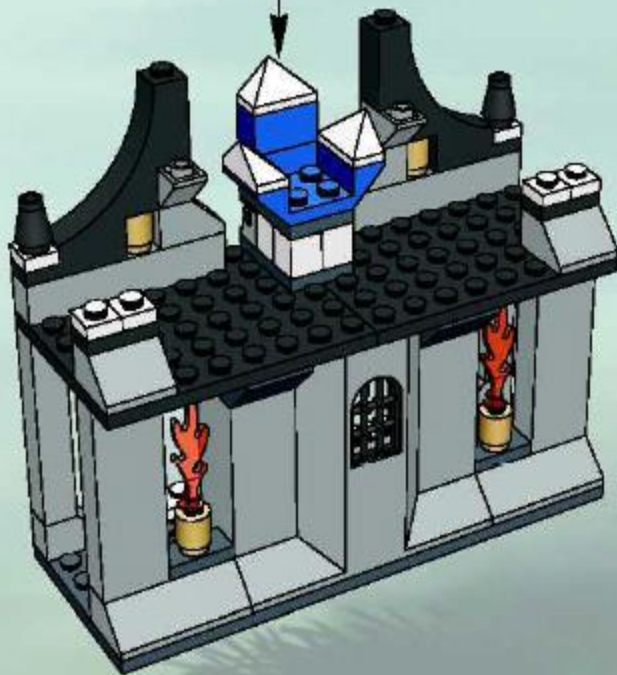

15

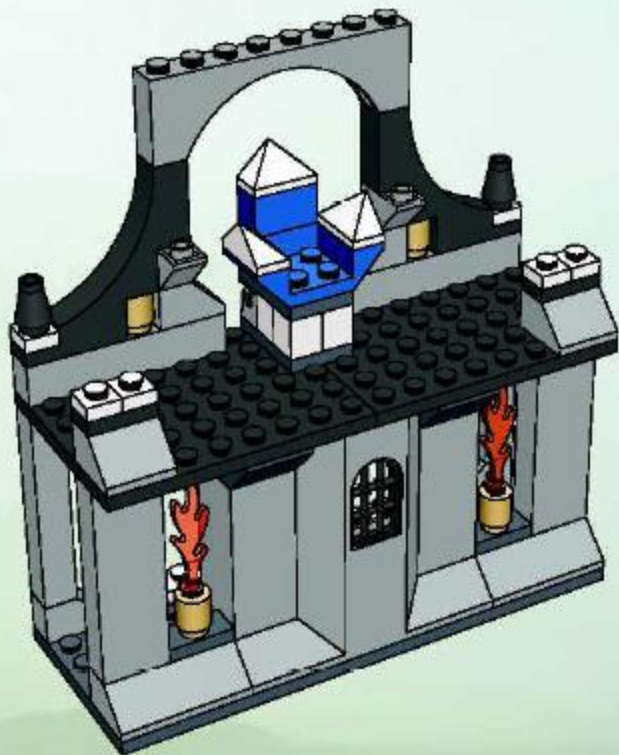



16

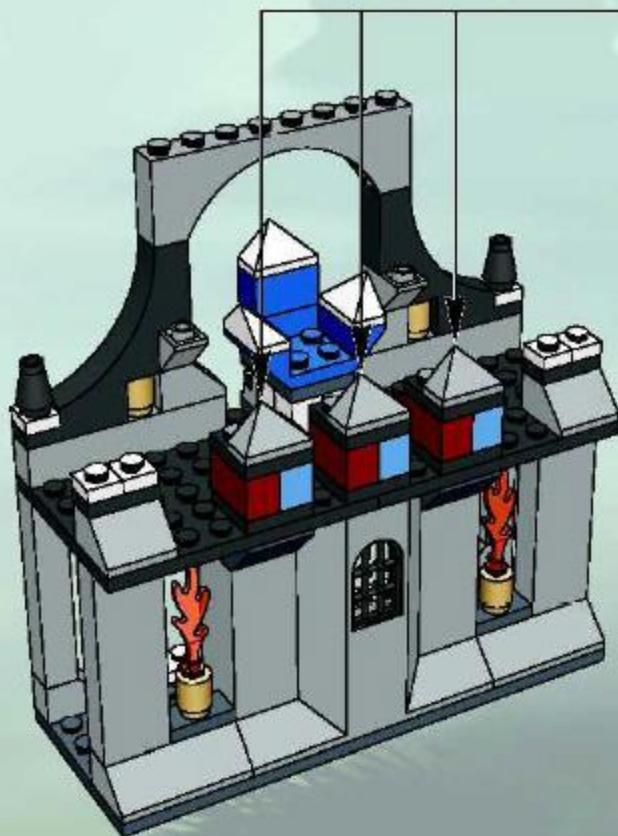

17

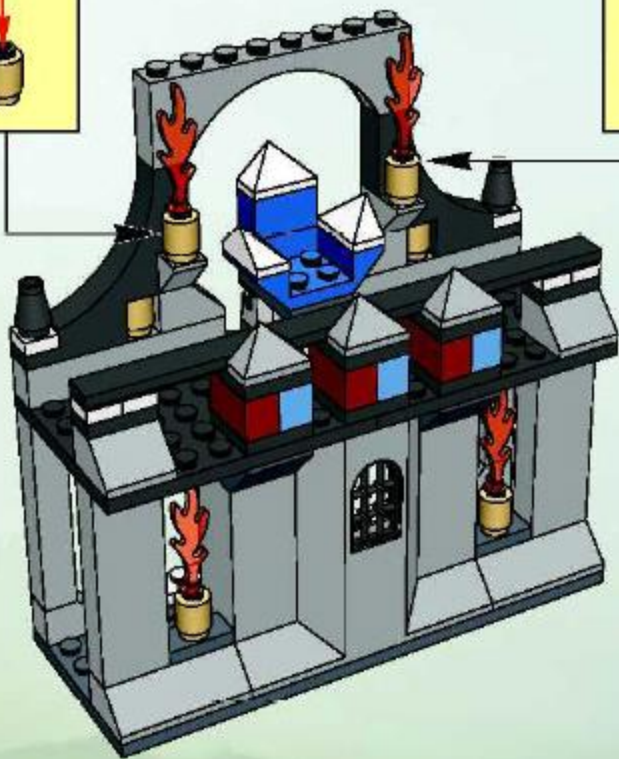
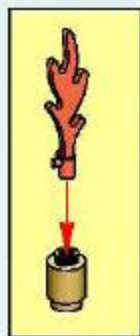
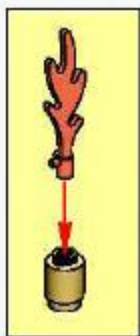

18

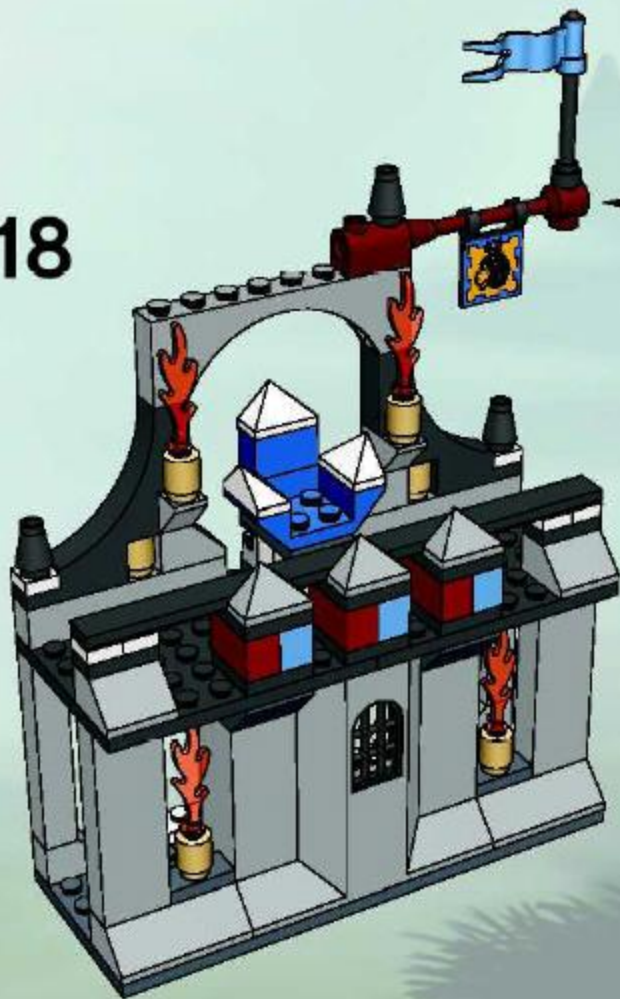

1



2



3



1



2



3



19

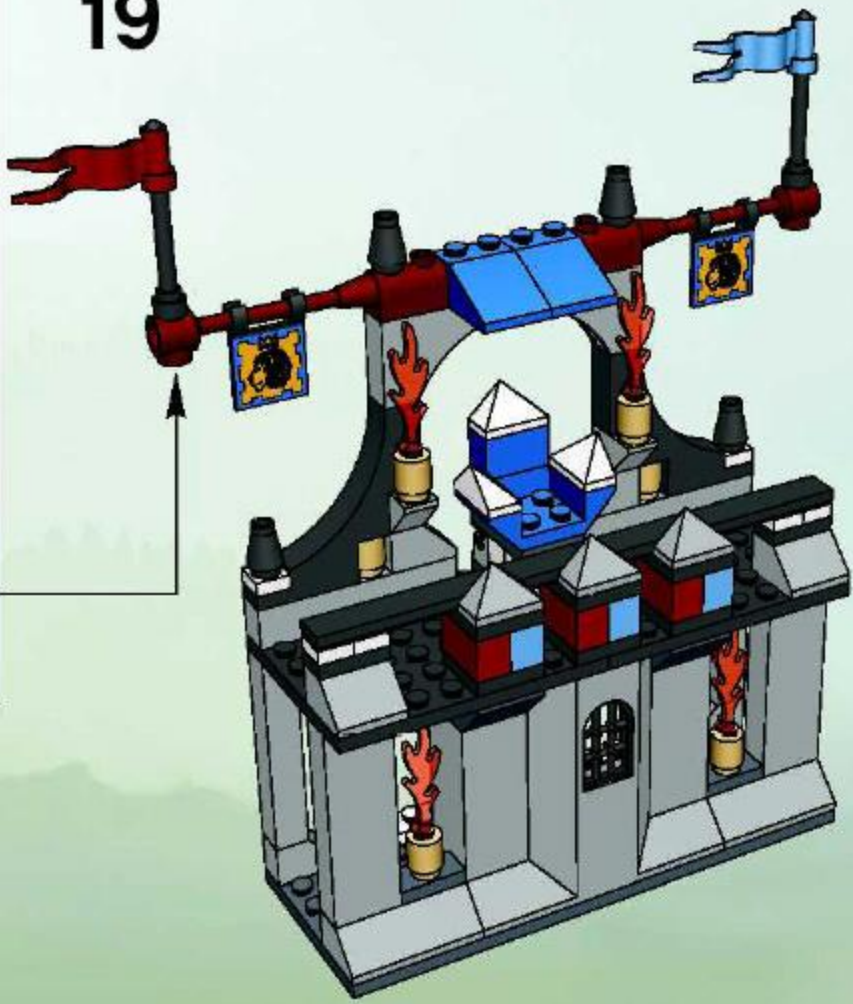

20

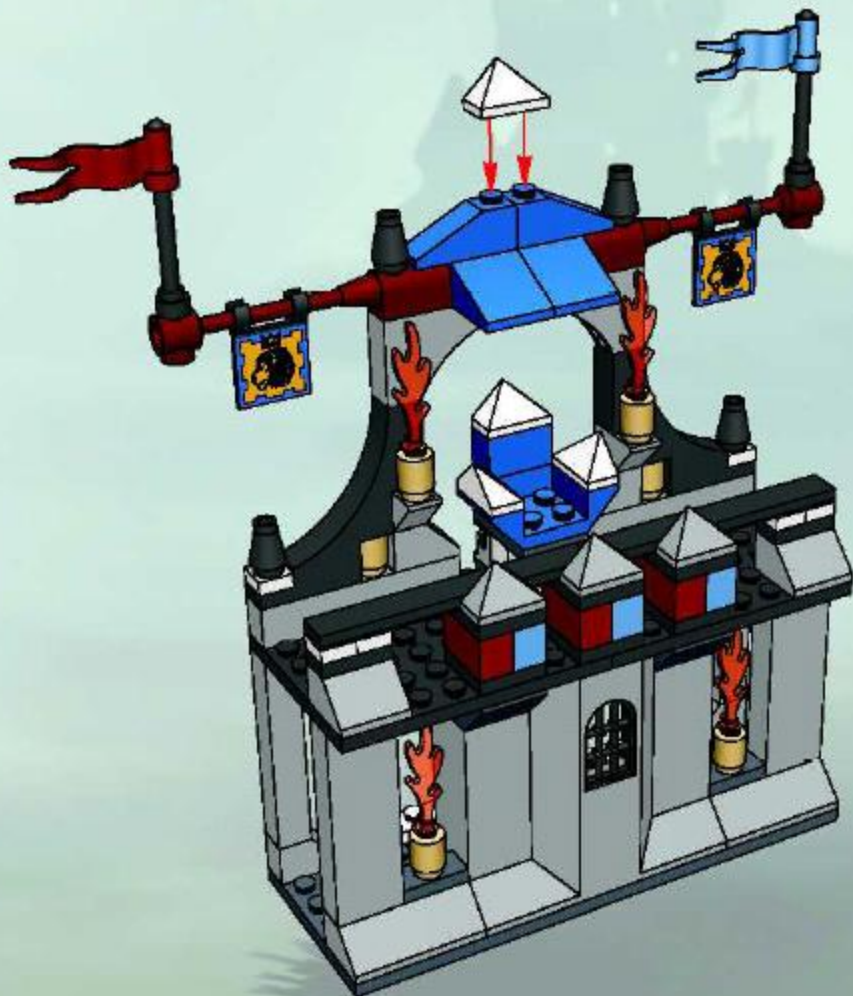

21





1



2



3



4



5



6



7



8





1



2

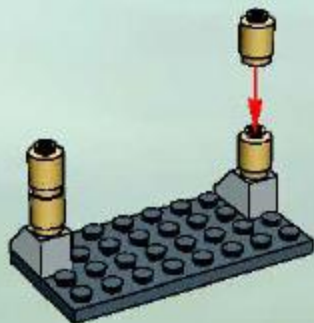

3



1



2

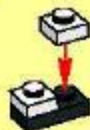

3



4

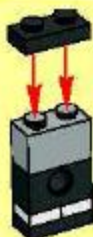

4

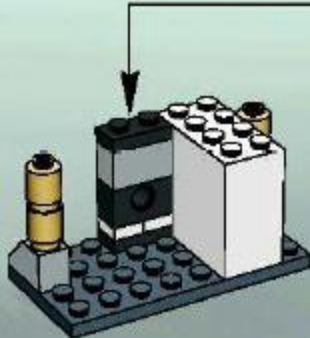

5

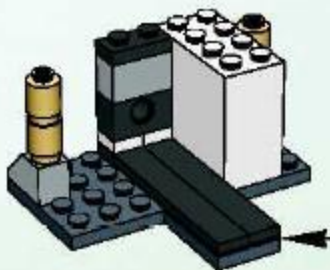

1



2



3



6

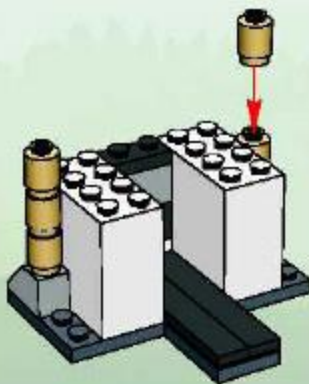

7

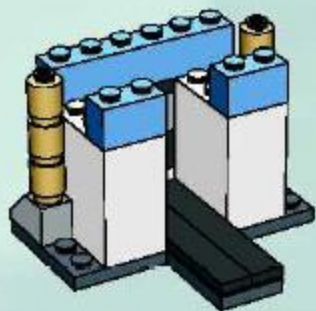

8

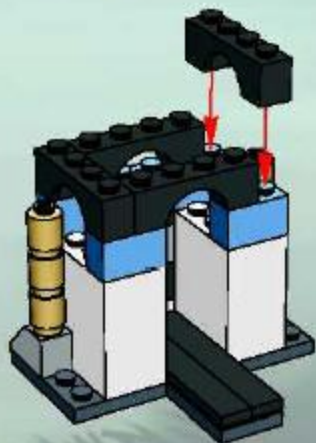

9

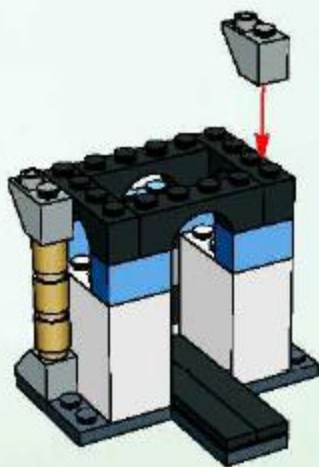

10

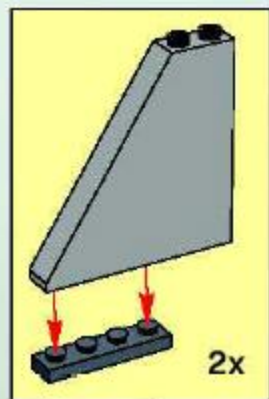
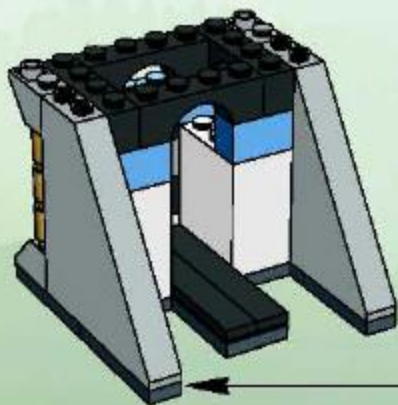

11

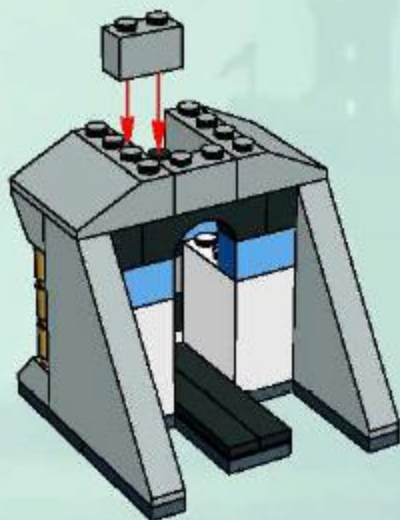

12

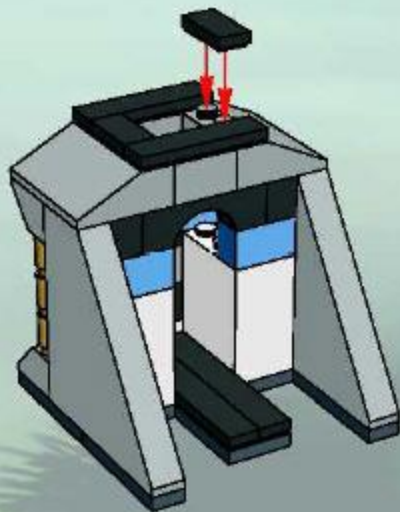

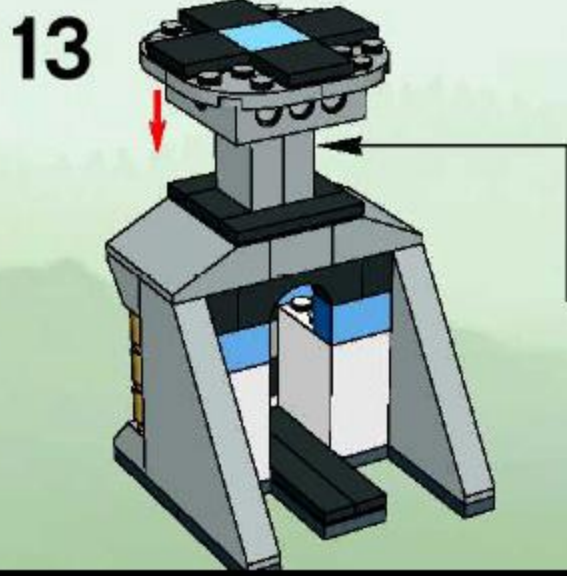
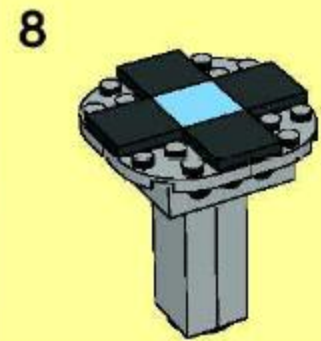
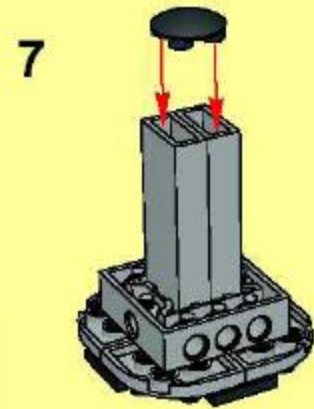
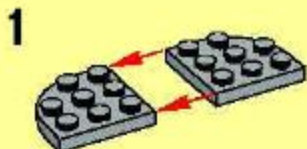



1



2

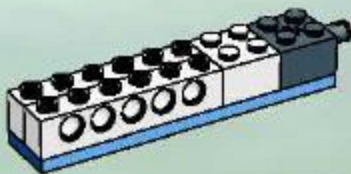

3

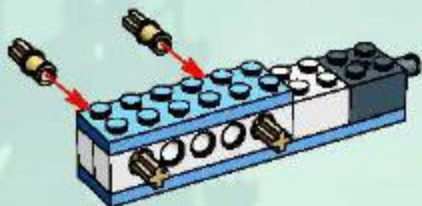

4

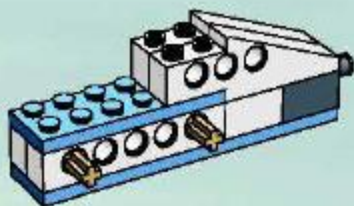

5

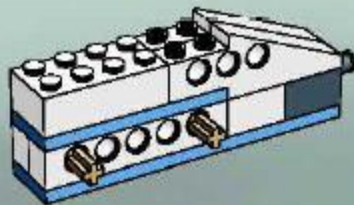

6

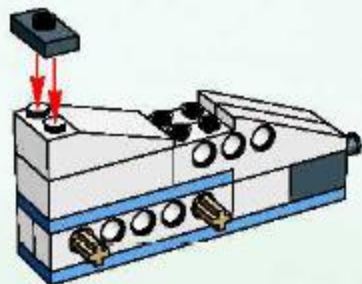

7

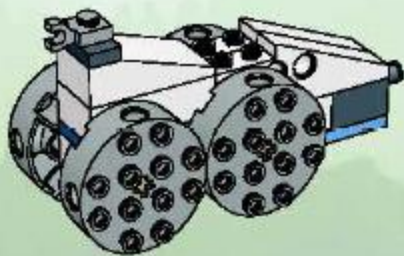

8

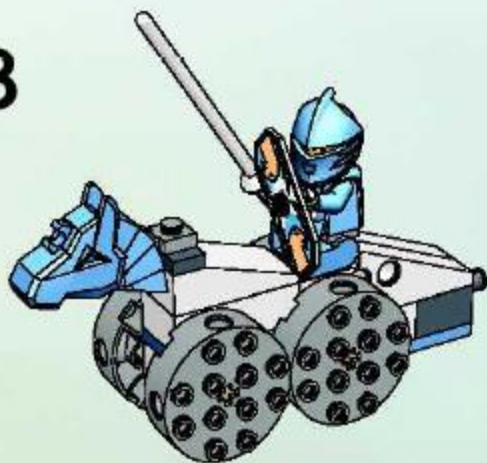

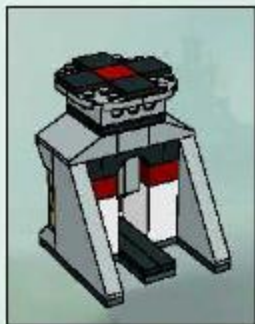

1



2

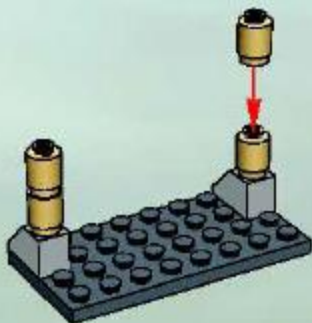

3

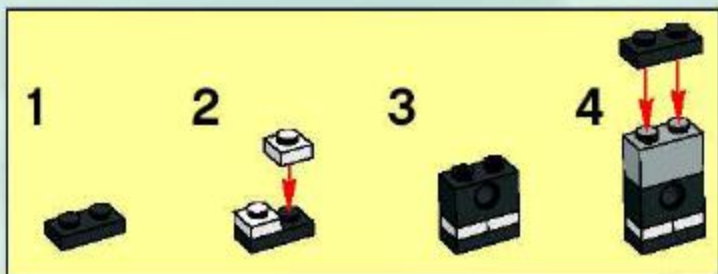

4

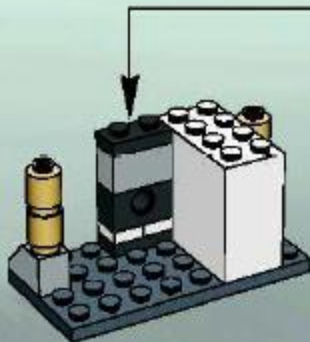

5

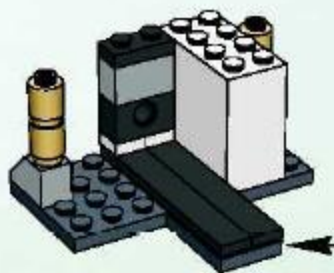

1



2



3



6

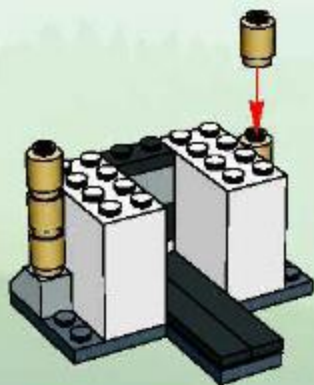

7

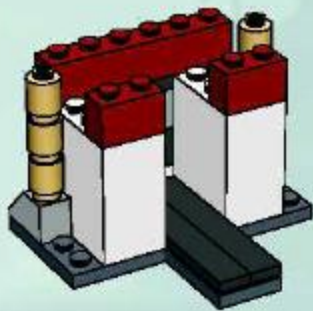

8

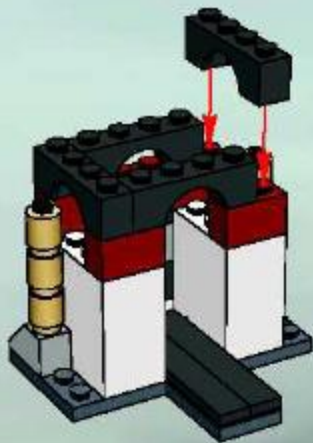

9

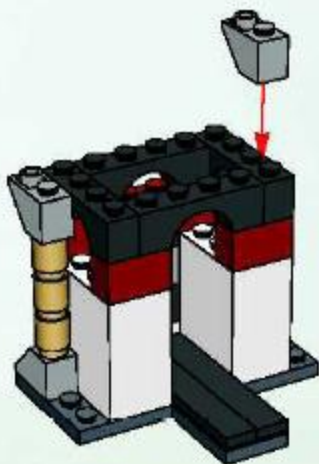

10

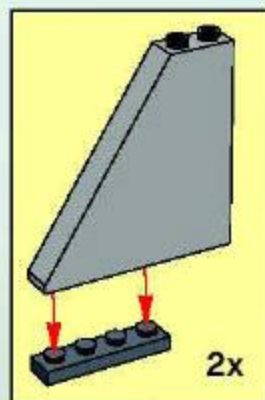
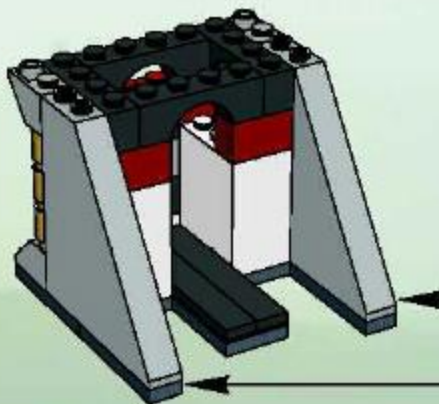

11

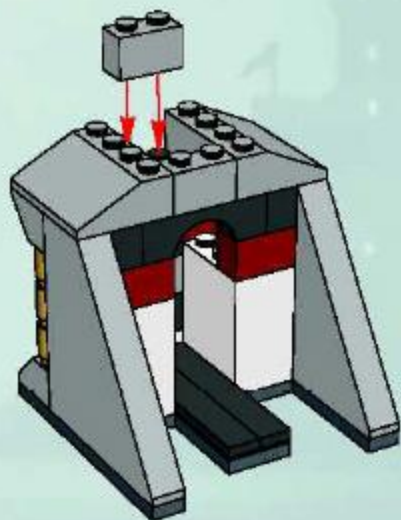

12

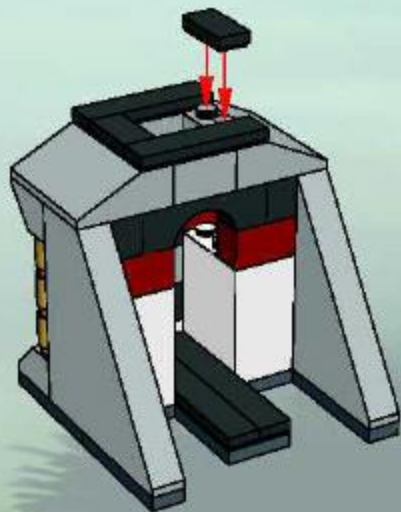

1

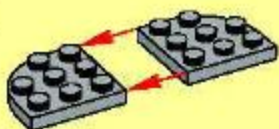

2



3



4



5



6



7

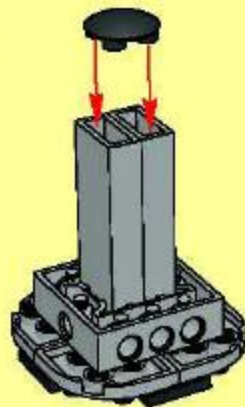

8



13

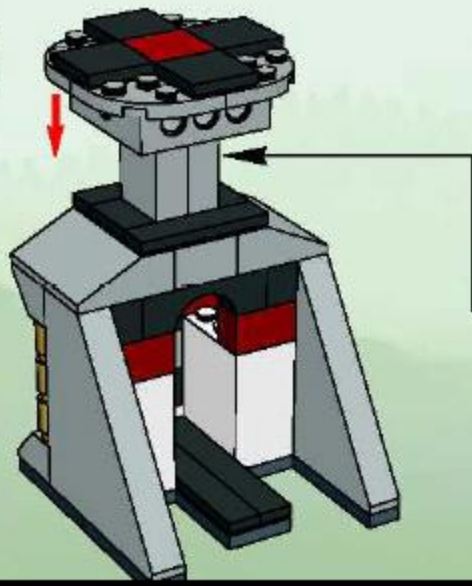



1



2



3



4

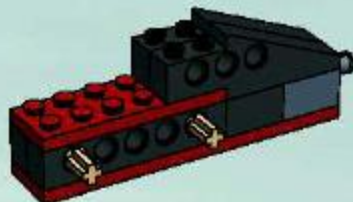

5



6

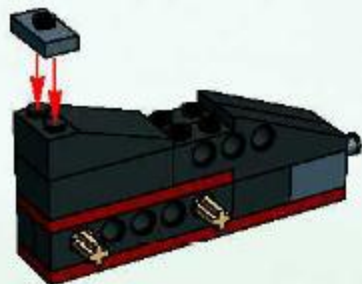

7



8



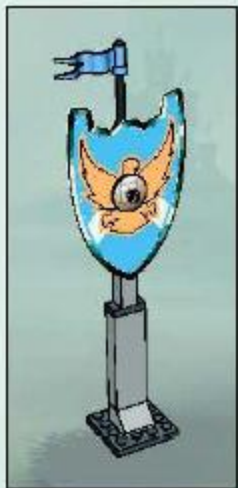

1



2



3

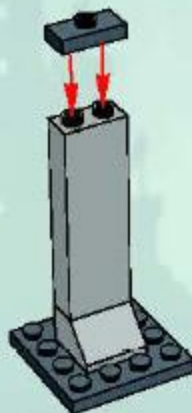

4

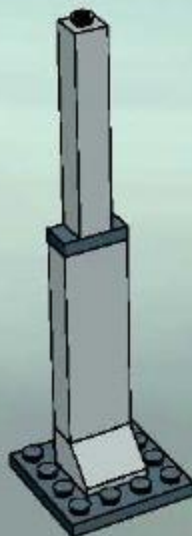

5

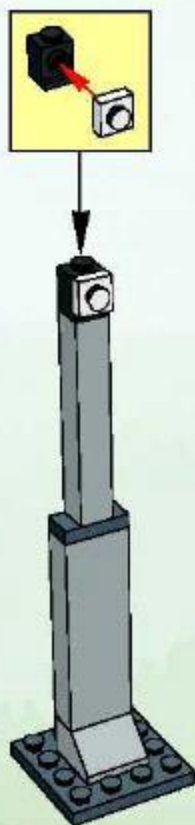

6

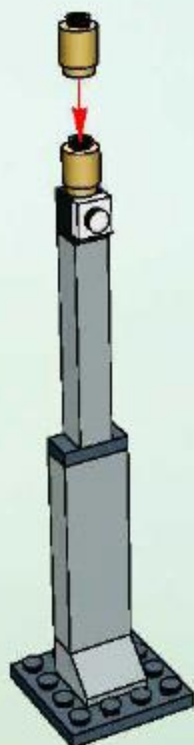

7

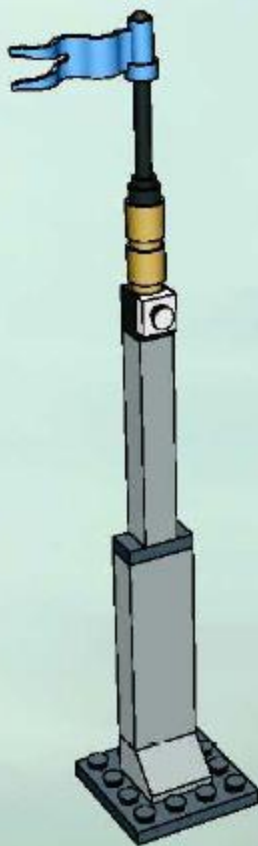

8



9



1



2



3

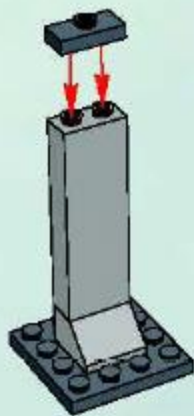

4

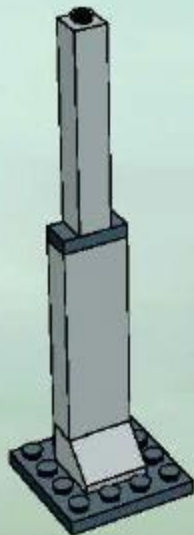

5

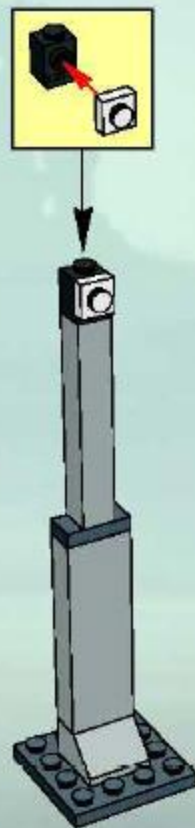

6

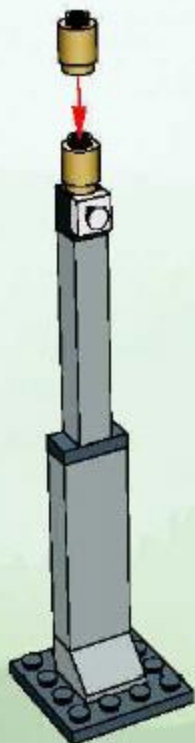

7

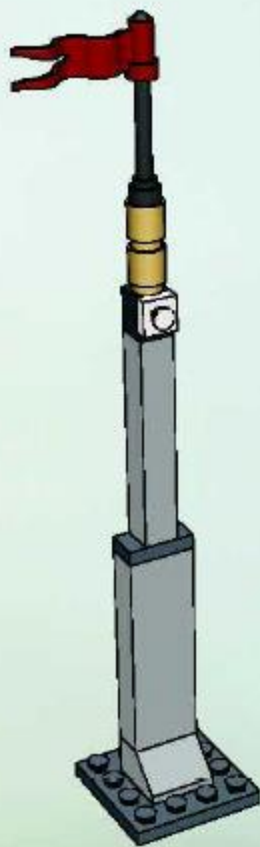

8



9



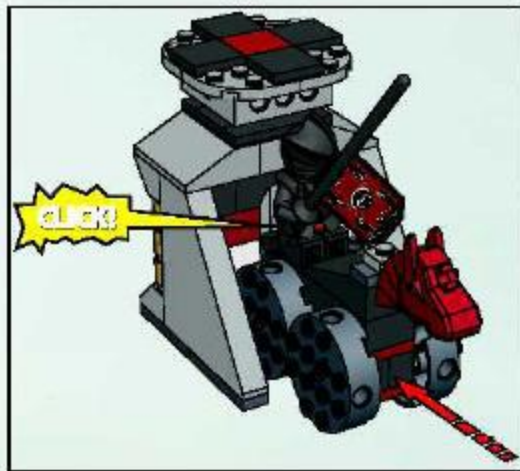

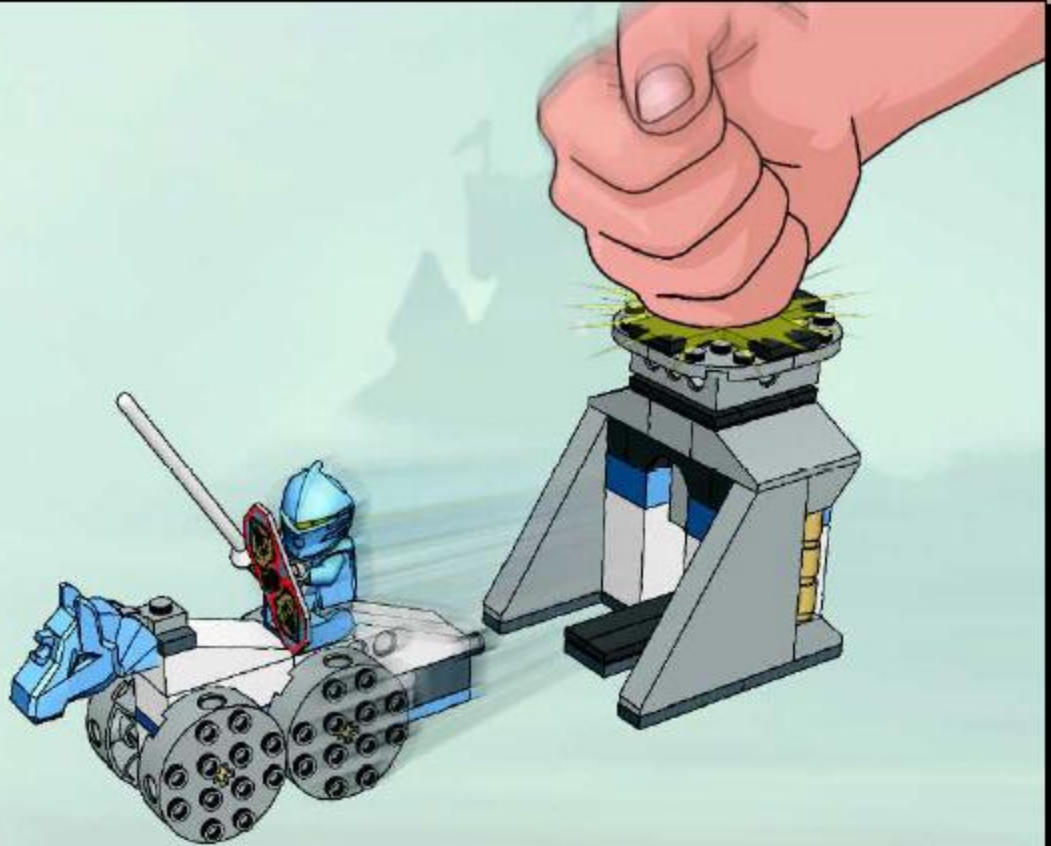



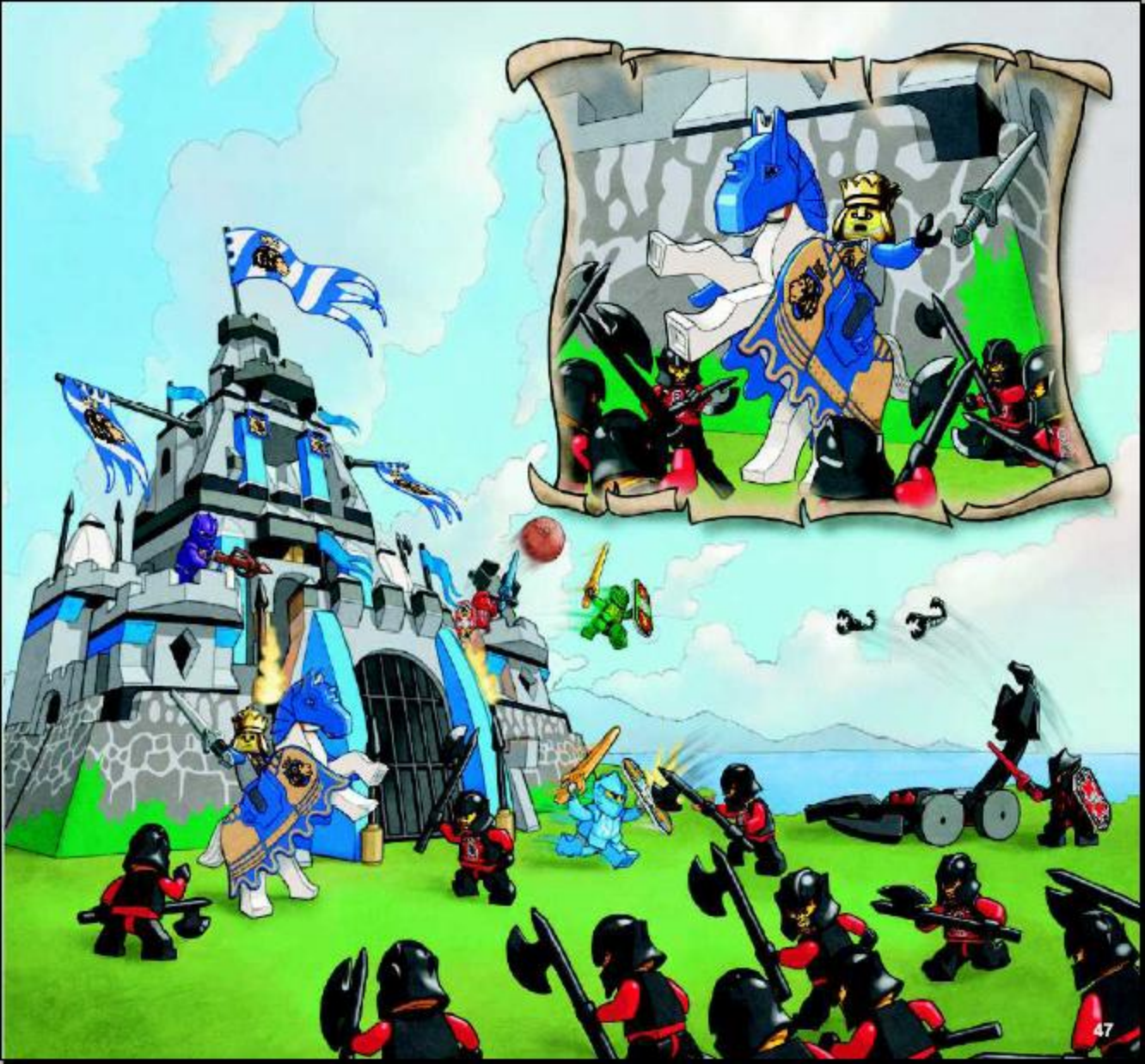







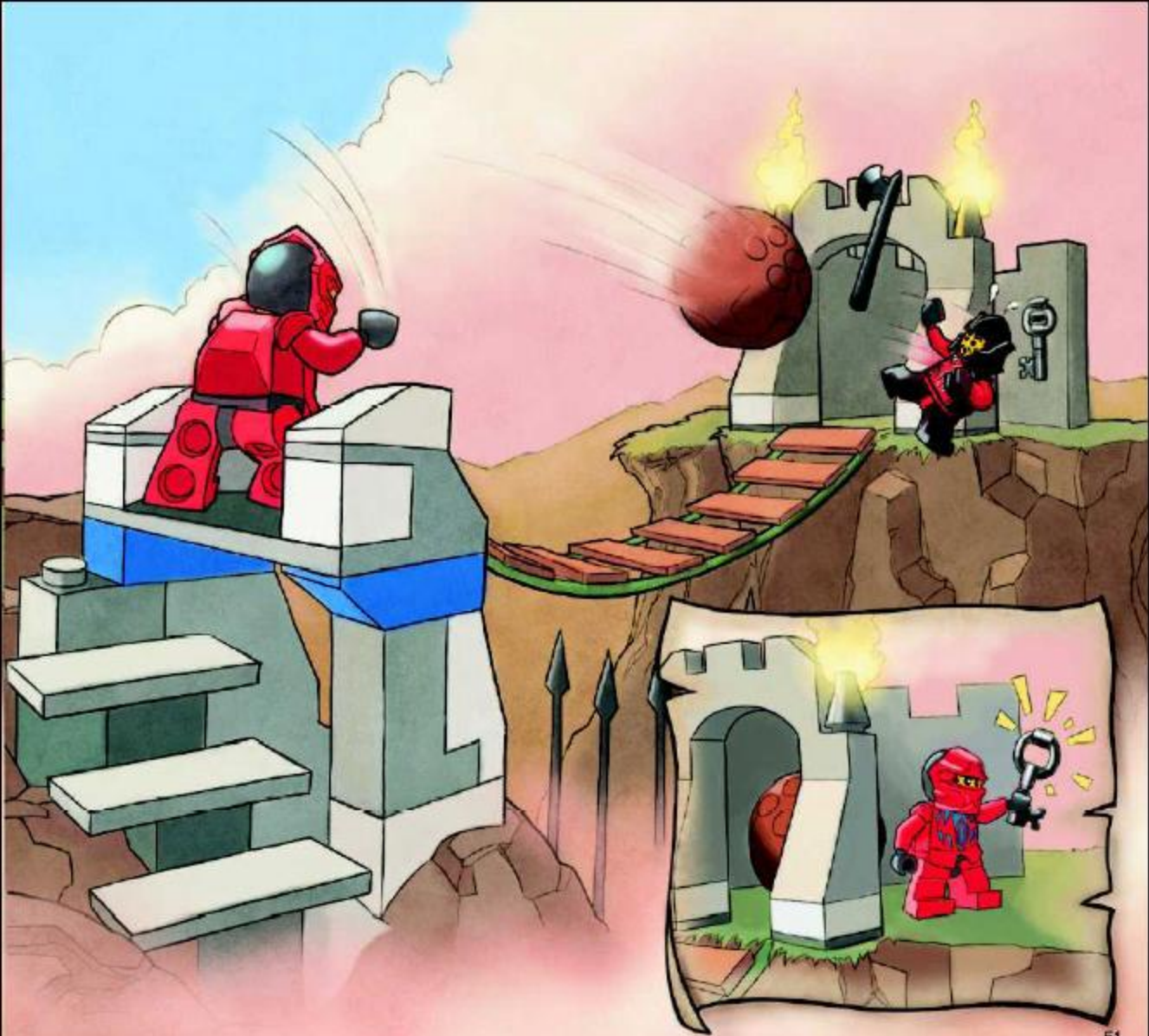







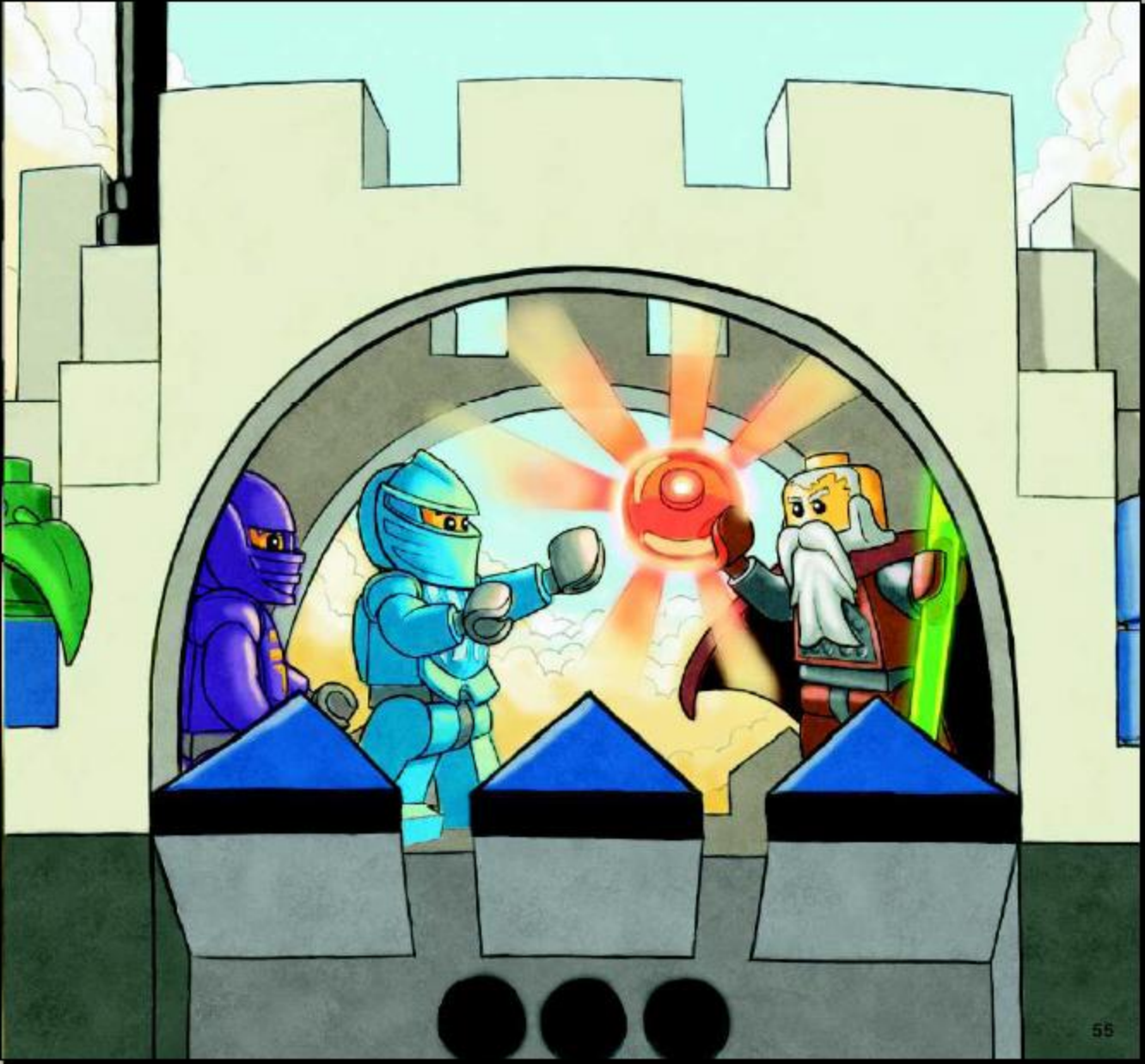









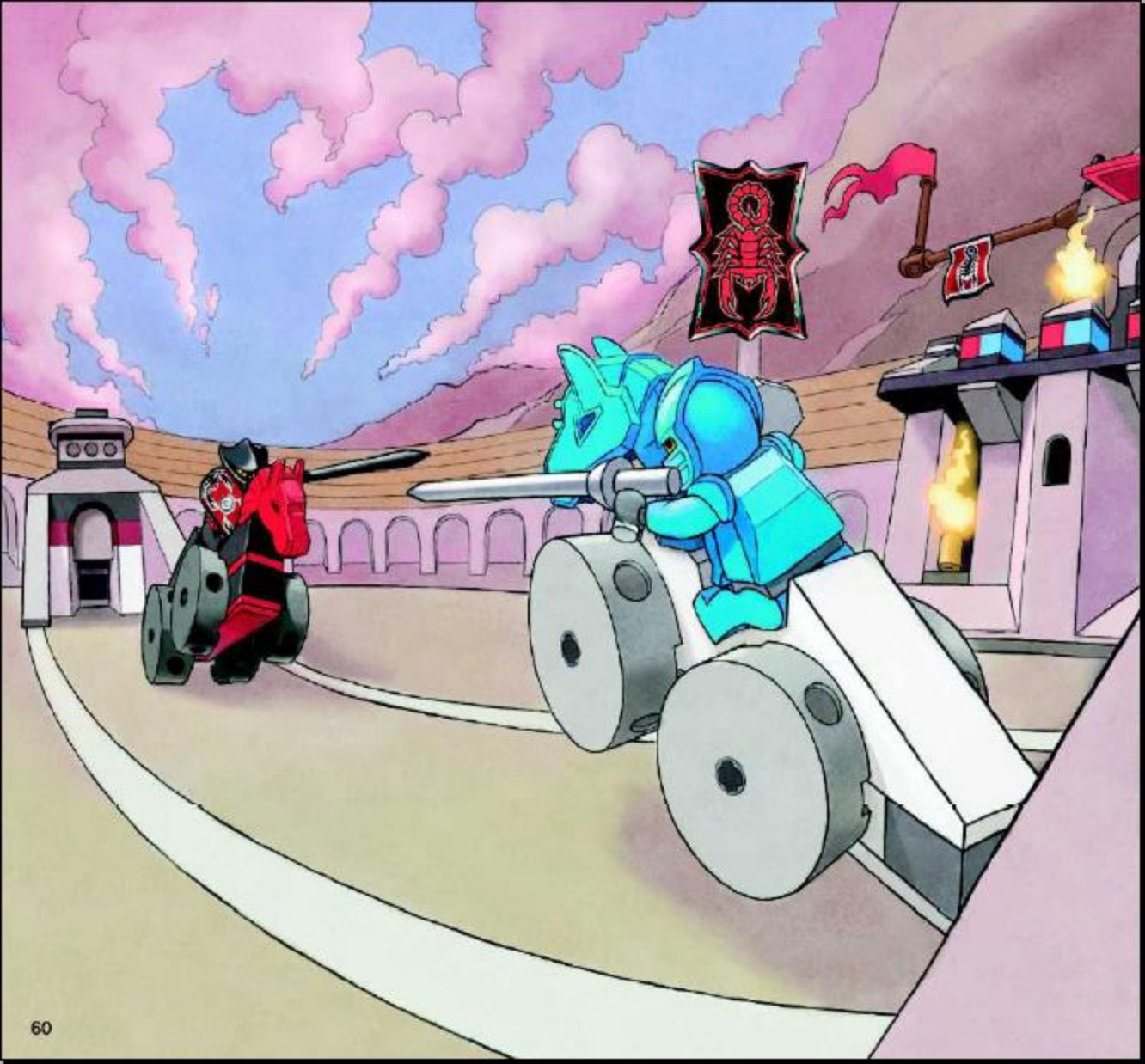





Win! Gagne! Gewinne! 当たります



WIN LEGO® PRODUCTS

We would like to know what you think about our new LEGO® product. If you could help us by answering a few questions you are in with a chance of winning an exciting LEGO prize. It will only take you about 3 minutes! Log on to the web address below for further instructions.



Estimado usuario LEGO®

Al contestar algunas preguntas en Inglés, francés, alemán o japonés, en el sitio www.acnielsen.aim.dk/lego, podrás participar en el sorteo de algunos valiosos premios LEGO®.



皆様でレゴ®製品が大好きです

私たちは、皆様からの新しいレゴ®製品について何かを教えてください。99秒以内の時間で、質問に答えて、あなたはレゴ®の素晴らしい賞品に当たるチャンスがあります。わずか3分程度で完了し、あなたの意見が私たちのために役立ちます。



GAGNE DES PRODUITS LEGO®

Nous aimerions savoir ce que tu penses de ton nouveau produit LEGO®. Si tu veux bien nous aider en répondant à quelques questions, tu recevras peut-être bientôt un fantastique prix LEGO. Et cela ne te prendra que 3 minutes environ ! Tu obtiendras davantage d'informations en visitant le site Internet indiqué ci-dessous.



Caro Consumidor de LEGO®

Ao responder a algumas perguntas em Inglês, Francês, Alemão ou Japonês no endereço www.acnielsen.aim.dk/lego irá participar num concurso para ganhar valiosos prémios de LEGO®.



GEWINNE LEGO® PRODUKTE

Wir sind sehr an deiner Meinung über dein neues LEGO® Produkt interessiert. Wenn du uns den Gefallen tust und ein paar Fragen beantwortest, kannst du einen tollen LEGO Preis gewinnen. Das Ganze dauert nur etwa 3 Minuten! Gehe einfach zu der unten angegebenen Webadresse - dort findest du weitere Informationen.



Kedves Új LEGO® Vásárló!

Ha ellátogatasz a www.acnielsen.aim.dk/lego honlapra és ott angol, francia, német vagy japán nyelven megválaszolod néhány kérdést, akkor részt vehatsz egy versenyben, amelyben értékes LEGO® ajándékot nyerhetsz.

www.acnielsen.aim.dk/LEGO



LEGO

KNIGHTS OF KINGDOM



4200082



8786 **VLADEK**



8784 **RASCUS**



8785 **SANTIS**



8783 **JAYKO**



8782 **DANJU**